



SPRING NEOTAP

NEOTAP - Hot, Cold, Sparkling MultiTap LC

INSTALLATION AND OPERATION GUIDE



CONTENTS

Preface - Underbench Parts	1
Multitap - Extended Diagram	2
Piping Installation - Diagram	3
Piping Installation	4-5
Boiler - Installation/Operation	6
Co2 - Installation/Operation	7
Mixer/Faucet Operation	8-9
FAQ	9-10
Fitting Guide, Leakage Detection Device, Swivel Tap - Warning	11-12
Data Sheet	13

Please read these instructions completely before operating this unit

PREFACE - UNDERBENCH PARTS

Before using this machine, we advise you to read this manual thoroughly. Please follow the instructions to ensure proper operation and the lasting of the machine

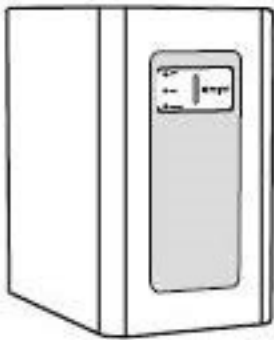

Neotap - Underbench
Boiling, Chilled, Ambient



Boiler Unit

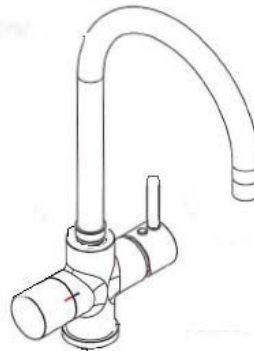

Faucet
(Fittings shown in
extended diagram)



with adapter
2.2L CO2



KDF50 Filter



1/4" Pipe
Used for ambient
water and Co2 gas

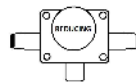

Pressure Reducing Valve
(PRV)



Power Cord x2
(NEOTAP and
BOILER)

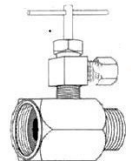





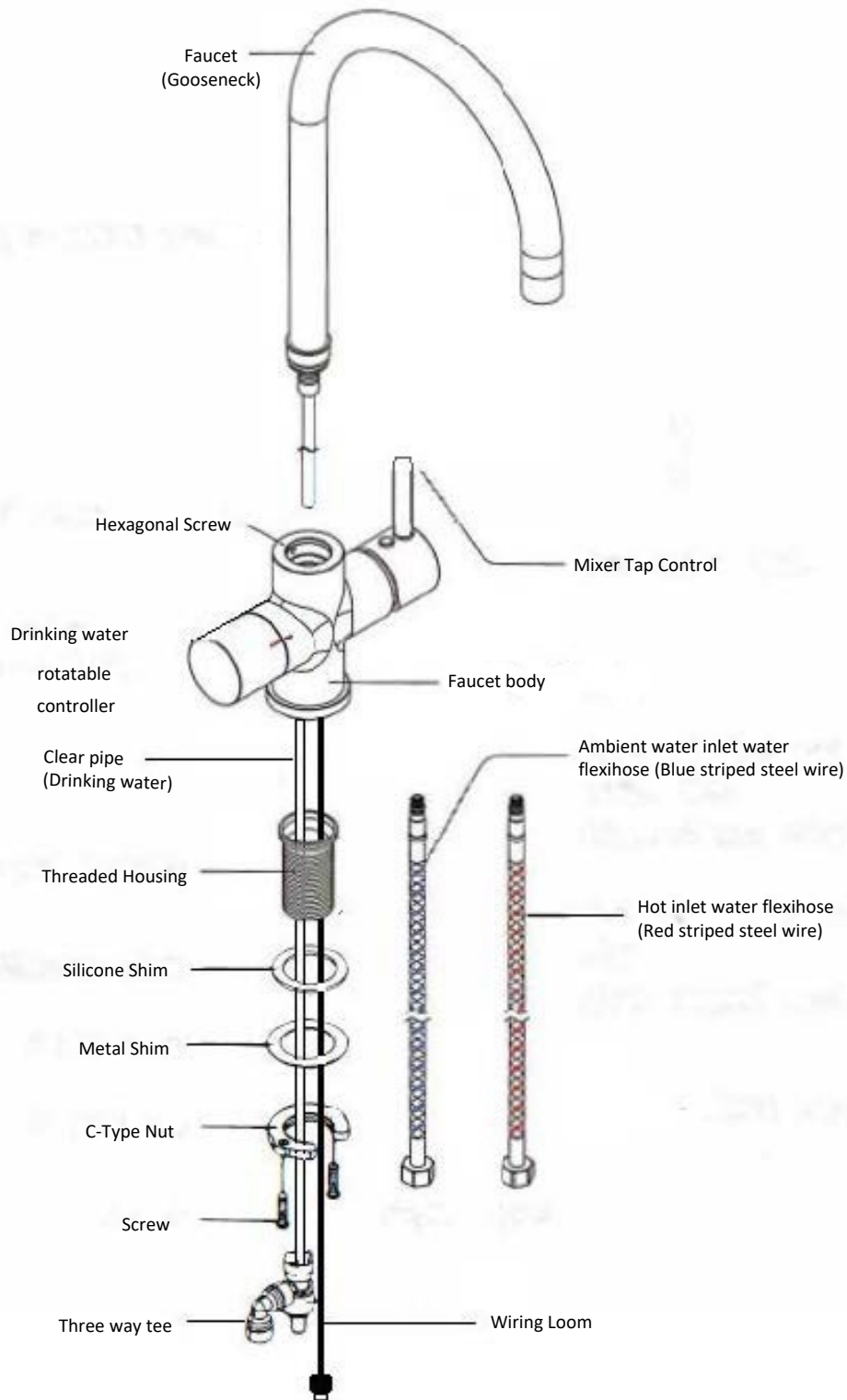

Brass Tee Off Valve
(Plumbers Delight)

MULTITAP - EXTENDED DIAGRAM



Please check the parts are all correct in the box, and read the manual thoroughly. To install and use the faucet by following instruction to avoid damage

PIPING INSTALLATION - DIAGRAM-

-  Flexihose RED (HOT)
-  Flexihose BLUE (COLD)
-  1/4" Pipe (Connected to tee)
-  1/4" Pipe (Ambient water/Co2 gas)
-  Wiring Loom
-  Grey Silicone Pipe (HOT)

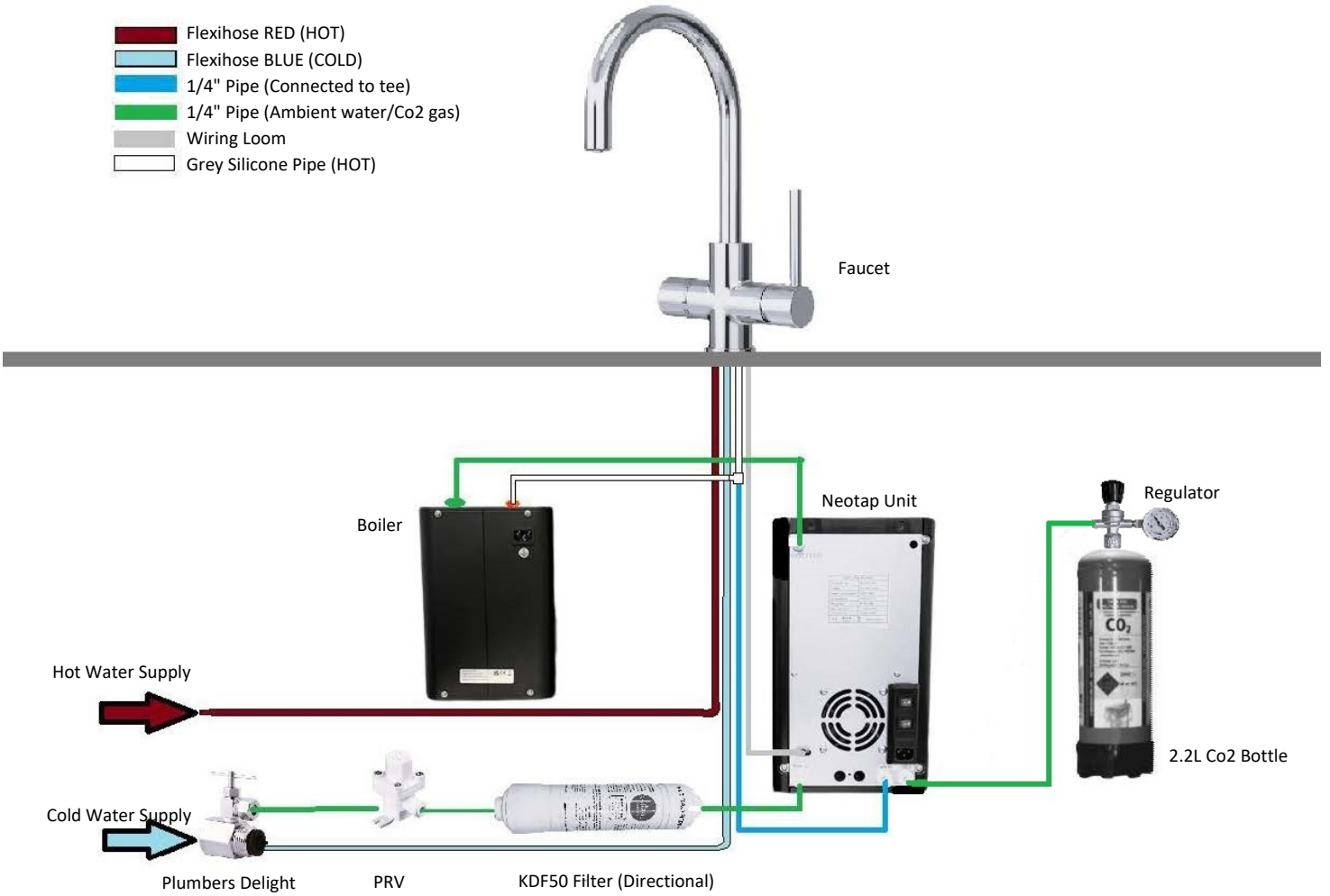

PIPING INSTALLATION

We recommend the instructions specified in this guide be followed in sequence by a qualified tradesperson for successful installation.

This Neotap has a 24 month back to base warranty from purchase, but this may be voided if unsatisfactory installation results in damage to the unit.

1. Select the appropriate position for the tap to ensure it dispenses into the sink, allowing ample clearance below the outlet and at least 50mm from the wall. Drill a 35mm hole
2. Isolate the water supply. Disassemble the original COLD water Tap/Flexihose connections. Reconnect the plumbers delight inline
3. Using the 1/4" Pipe provided connect the 1/4" inlet ball valve to the Pressure Reducing Valve. The PRV is then connected to the KDF50 Filter and finally into the water inlet. Please ensure the filter has been flushed before connecting. The PRV and Filter have a directional water flow, connect as marked on the part
4. Connect the 5/16" Pipe from the Faucet to the top of the one way tee valve (Grey HOT tube, and White COLD tube already attached)
5. Feed the faucet (Including pre-attached pipes) through the pre-drilled hole. Position so the tap sits flush with the bench-top
6. Following the MultiTap Install guide Pg.3 Screw and tighten the tap nut to ensure the tap is correctly positioned on top. Be careful not to over-tighten as this may split the nut NOTE: Once placed do not swivel the tap - Internal tubes and cables within the faucet cannot handle rotation more than 180deg and risk being damaged
7. Find the best place for the NEOTAP unit, Boiler and Co2 bottle under the bench, allowing 150mm clearance around the top and rear of both units for ventilation. Allow room for the filter and piping as specified above
8. Connect 1/4" pipe from the Hot Water outlet of the Neotap to the Cold Water inlet of the Boiler (Push Lock)
9. From the One Way Tee Valve - Connect the GREY pipe to the HOT water outlet at the top of the Boiler (Pressure Fit) and the White 1/4" Pipe to the COLD water outlet at the bottom of the Neotap (Push Lock)
NOTE: Ideally the GREY pipe should flow in a straight line upward. This pipe can be shortened and should be as short as possible for best hot water supply
10. Connect the RED Flexihose to the HOT Mains Water Outlet, and BLUE Flexihose to the COLD Mains Water Outlet for the mixer side of the tap
11. Carefully attach the wiring loom to the NEOTAP unit
12. Connect the machine to the power supply using the cords at the rear of the units. Leave power and water supply OFF
13. Ensure all fittings, electrical connections and piping are secure to and from the unit
14. Turn on the water and power supply at the wall but not on units

PIPING INSTALLATION - CONTINUED

Co2 Bottle Installation : Please skip to step 16 if you have a Non-Sparkling model

12. Place the Co2 bottle upright in the undersink cavity as close to the NEOTAP unit as possible

Disposable Gas Bottle and Regulator - Instructions

1. To connect the disposable gas bottle, first thread the adapter onto the gas bottle making sure the dial at the top is closed (Completely anti-clockwise)
2. Attach the regulator to the adapter making sure the regulator is also in the OFF position (Completely anti-clockwise)
3. Open the gas bottle by turning the dial at the top of the adapter clockwise

[Continue to Step 15](#)

Reusable Gas Bottle and Regulator - Instructions

12. Turn the knob fully anti-clockwise to ensure the regulator is in the OFF position
13. Connect the Co2 bottle to the regulator by screwing the regulator onto the bottle firmly (Clockwise). Be careful not to overtighten to avoid damaging the nut
14. Open gas bottle by turning the main bottle valve anti-clockwise
15. Attach the regulator to the open Co2 connector at the rear of the unit using the 1/4" pipe provided. **DO NOT OPEN THE REGULATOR** - This is addressed in Co2 operation
16. Ensure the whole unit and its components have at least 150mm ventilation surrounding
17. Check there are no kinks or "sag" in the tubing from the unit to the faucet. This will ensure that any reduction in water flow is reduced
18. Ensure all fittings, electrical connections and piping are secure to and from the unit

BOILER - OPERATION INSTRUCTIONS

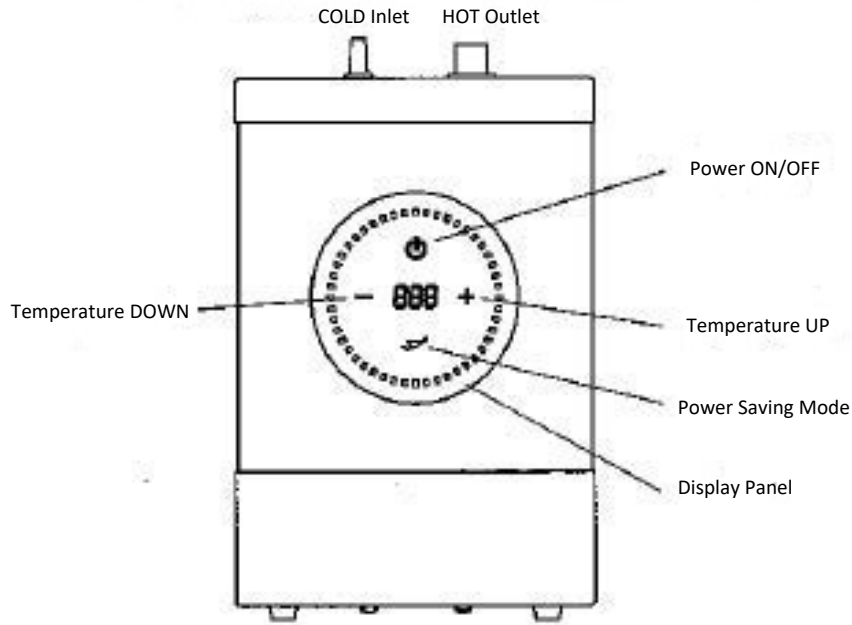

Once connected as outlined in the piping instructions connect the BOILER to power at the wall. Leave the power switch off at this stage (This is important, as if the boiler is turned on before water has run through the unit it does run the risk of burning out the element)

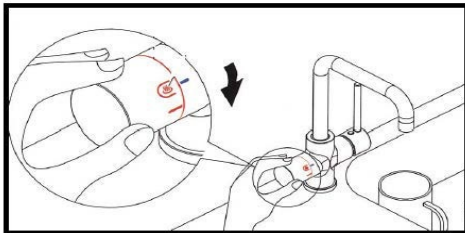

Ensuring the NEOTAP is turned on at the wall, turn dial on the left hand side of the faucet so the indicator is in line with the HOT water icon. The Red LED light should start to flash

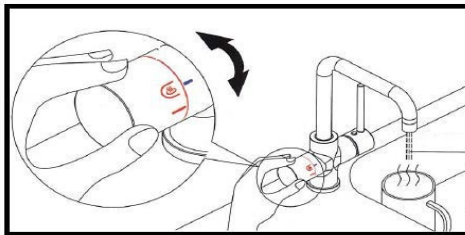

Turn the dial so the RED and BLUE lines align (LED will be blue)
Finally, turn the dial back to the HOT icon. The LED will turn Red within 2 seconds

Leave on this selection until ambient water starts to dispense from the faucet (Can take 1-2 minutes)

The boiler has now been primed correctly. Turn on the BOILER by holding down the power button until the lights at the front of the unit illuminate

BOILER - TEMPERATURE ADJUSTMENT

Internal thermostat is adjustable between 75 - 98 degrees C
You can adjust the temperature by pressing the - and + buttons on the front of the Boiler
While the unit is heating to the desired temperature the red LED will circulate the display panel
Once fully heated all the LEDs circulating the display panel will stay on (stationary)

CO2 BOTTLE - INSTALLATION

1. Ensure the Co2 bottle is connected firmly to the regulator and the Co2 tube is fitted correctly
2. Slowly turn the dial on the regulator clockwise until the gauge reads 3 bar
(Note: if you want to reduce the pressure you must first turn the dial anti-clockwise and then vent to relieve existing pressure. The gauge will then settle and read accurately)
3. Turn off the water at the valve and purge any air from the sparkling line by turning your selection to SPARKLING on the tap for 30 seconds
4. Turn the water back on at the valve and the SODA switch on at the rear of the unit
5. Press the sparkling button on the tap for 15 seconds to allow any excess Co2 to be dispensed
6. Turn to the SPARKLING selection on the tap 2-3 times for 15 seconds each time (1 minute cool down) until you notice the water is sparkling. Pressure will fluctuate between 3-4 bar

[Best sparkling performance after 24hrs from installation](#)

All Co2 bottles should be upright during use. If the bottle has been left horizontal, place upright and stand for 60+ minutes before use to allow contents to settle

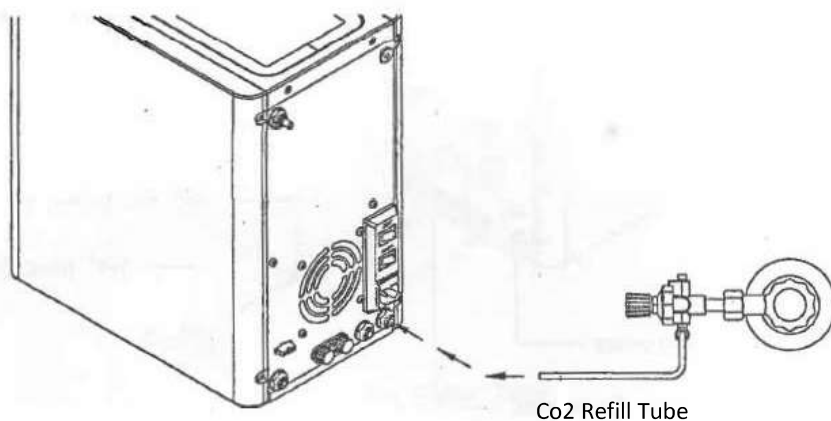

TOP VIEW - Co2 Bottle

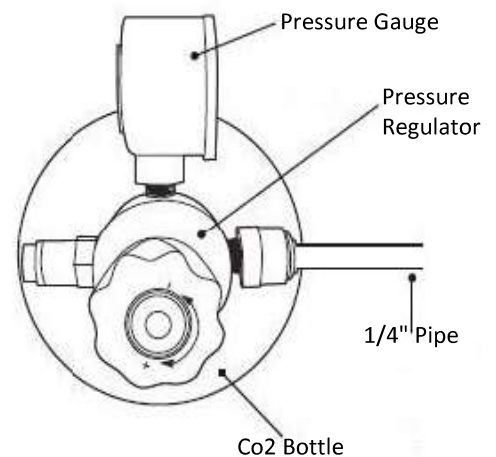

MULTITAP - MIXER INSTRUCTIONS

The Mixer Tap will be ready for use as soon as the installation is completed
It works independently of the Neotap unit

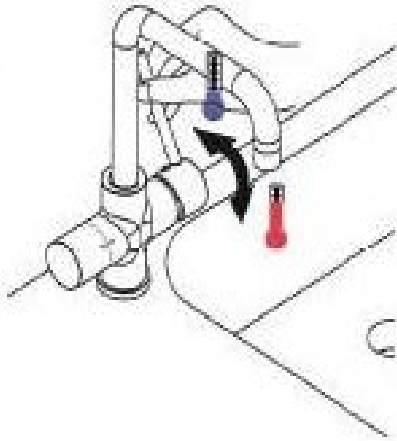

Hold mixer lever on the right hand side of the faucet and rotate in the direction of the arrow required for a spectrum of Hot to Ambient Water

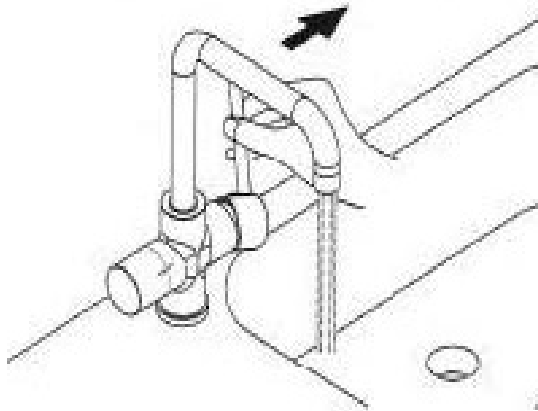

Pull the lever out to the right in the direction of the arrow to dispense water

MULTITAP - FAUCET INSTRUCTIONS



There are 3 functions on the rotation controller and icon for turning on and off water supply

To Operate

Choose the option you require and align the indication marking on the body with the icon on the dial

When dispensing COLD or SPARKLING the green LED will be on

To stop dispensing water align the blue lines on the dial and body of the faucet

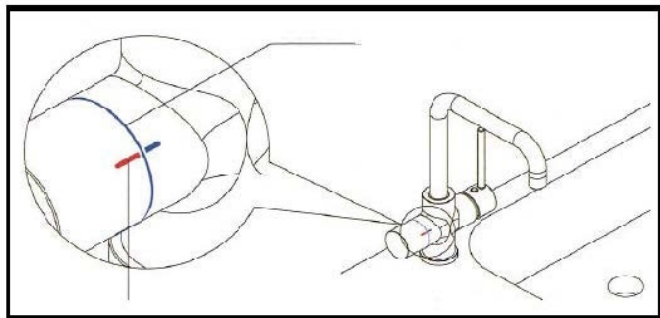

For best results allow 5 seconds to pass before using the next option This allows the pipe to completely fill with the chosen water option and dispense

CAUTION: For a short period after dispensing hot water the line will retain heat while line fills

MULTITAP - HOT WATER FAUCET INSTRUCTIONS

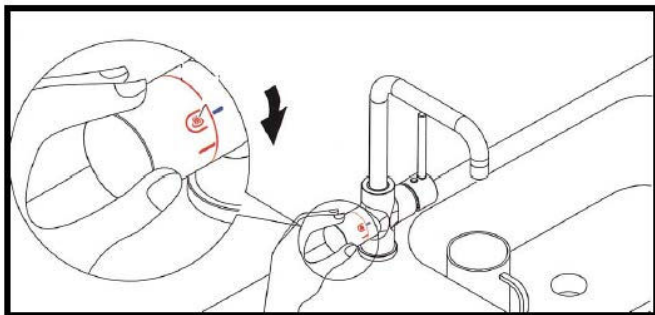

To dispense HOT Water first rotate the controller to HOT water icon to unlock - HOT Water will not be dispensed. Rotate back to the STOP Position Then rotate again within 2 seconds while the RED LED is blinking. The Red LED will then stop blinking and start to dispense steaming Water

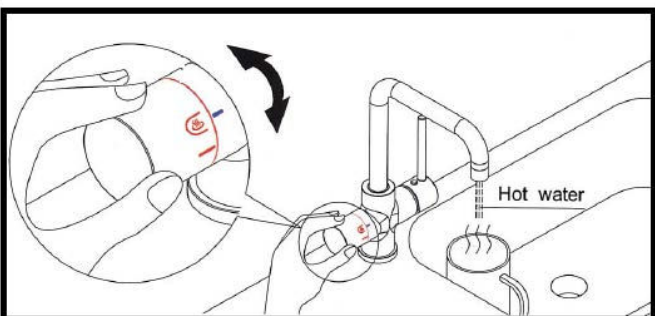

For best results allow 5 seconds to pass before using, this allows the pipe to completely fill with HOT Water

Please note the final temperature may vary dependent on the length of the tube, ambient air temperature and other factors. Most conditions result in 80-85 degree C steaming water

Trouble Shooting

Problem	Cause	Solution
Water isn't cold	Thermostat is off	Contact for service
	Refrigerant gas is low	Contact for service
	Problem with Compressor or Thermostat	Contact for service
No cold water from Tap	Ice blocking in system	Please turn off the COLD power switch to allow ice block to melt. Will need to contact for service to adjust thermostat
	No water inside unit	Check mains supply
LED at end of faucet flashing	Leak detection activated	Leak detection activated as probe detected water. Contact for service
Change in water taste	Filter change	We recommend changing the filter every 1-2 years. Turn of water supply and replace filter per diagram 1
Low Flow	Filter Change	We recommend changing the filter every 1-2 years. Turn of water supply and replace filter per diagram 1
	Insufficient water supply	Refill unit
Sparkling not working	Soda Power off	Check switch is on
	Co2 output pressure is too high making the water dispenser short	Close the Co2 bottle and release the pressure from the pressure regulator. Press the soda tap to drain out the water and release the pressure inside the tank. Turn off the SODA switch when water has drained. Reopen the Co2 bottle and set the Co2 output to 3 bar. Turn on the Soda Power switch again to start producing Sparkling water
	Co2 has run out	Refill Co2 bottle
	Co2 Line needs recomissioning	Follow the Sparkling Install Instructions Pg3-4
	Not enough bar pressure	Slightly increase Co2 bar pressure (Ideally between 3-4 bar)

CAUTION: For your safety please contact us or a qualified technician for repair if you suspect the water dispenser is damaged

PUSH LOCK FITTING - INSTRUCTIONS



1. Cut the 1/4" Pipe square and push into the fitting.

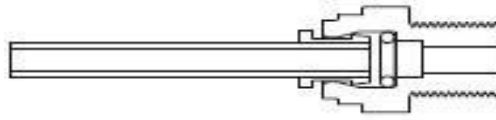

2. The Push lock fitting will grip before it seals. Ensure the pipe is pushed past the O-Ring into the fitting completely

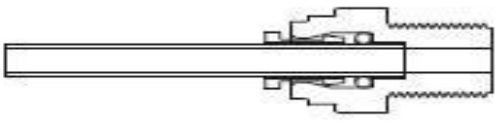

3. Pipe is secured in position. A small tug back will guarantee the pipe is in place

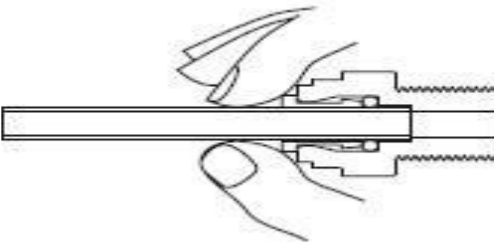

Disconnection

Pull locking ring flush against the fitting and hold. The pipe can now be released by pulling on it.

PLUMBERS DELIGHT - INSTALLATION

Disassemble the existing flexihose from the Cold Water Tap

Reconnect the plumbers delight inline

Use tee off for the 1/4 inch pipe to feed the Neotap

Connect the flexihose to the male plumbers delight connection to feed the mixer tap

1/4" Pipe to Neotap

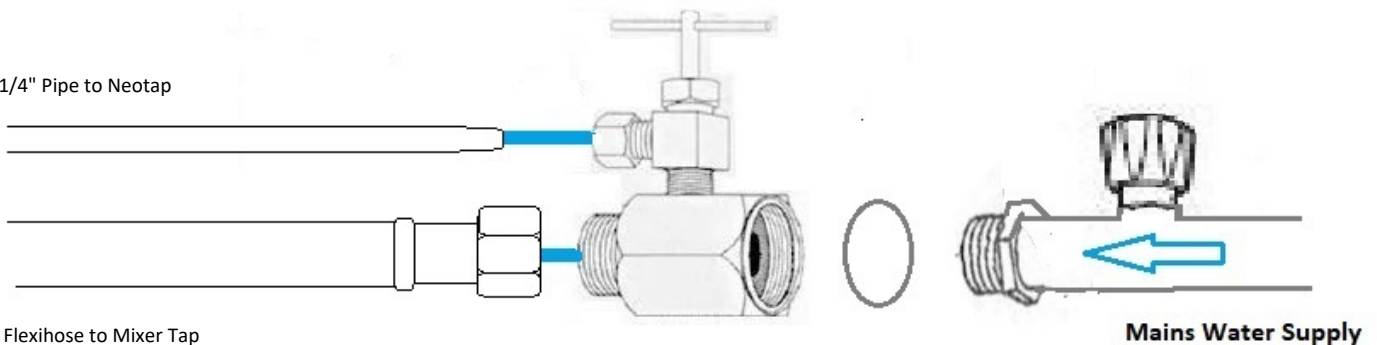

Flexihose to Mixer Tap

Mains Water Supply

LEAKAGE DETECTION - DIAGRAM

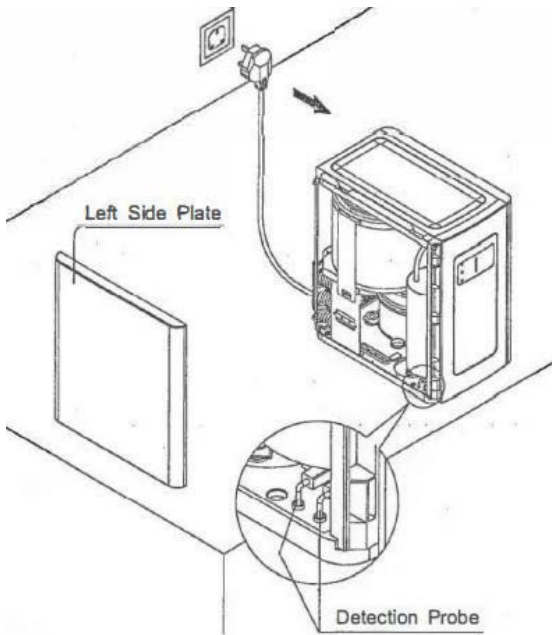

This device has a leakage detection probe fitted for safety purposes.
When the probe detects moisture you may notice the LED on the machine flashing accompanied by a beeping noise
We recommend turning off the electricity at the power supply and calling a qualified technician to carry out this work for your safety.

TAP SWIVEL - WARNING

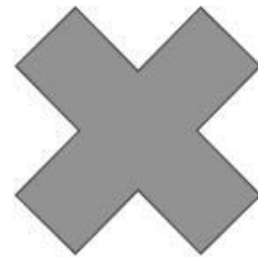

NO SWIVELLING TAP 360°

Internal tubes and cables within the faucet cannot handle completed rotation and will be damaged if turned more than 180 degrees.

Swivel feature is intended to find correct placement on the benchtop. Once placed, the tap should be left alone to avoid damage

PRODUCT DATA SHEET

Spring Multitap LC

INSTANT TAP

Overview

Underbench filter with integrated unit for boiling, chilled, sparkling and ambient drinking water

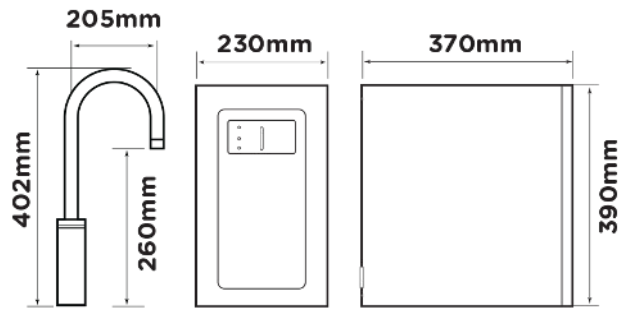

Model	sparkling, Hot, Cold + Mixer, Hot, Cold, Ambient + Mixer
Filtration	Premium KDF/GAC 50, 5 Micron Filtration
Cold Temperature	4C to 10C
Chilling Capacity	20 Litres per hour
Heating Capacity	12 Litres per hour
Chilling Power consumption	Direct chill system 100W
Weight	18kg
Tap Finish	Chrome, Matte Black, Brushed Nickel
Water connection	1/2 inch
Power requirements	2x Standard 10amp power outlet (earth leakage protected)
Max. recommended inlet pressure	500 kPa
Required hole for the tap	35mm
Ideal under sink dimension	(w x d h) 750 x 660 x 520mm